

INSTALLATION MANUAL

69072

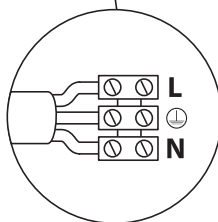

230V | COB LED | 3W | IP67
 Stainless steel 316L + Die cast aluminium body
 Tilttable beam.
 Complete with driver.

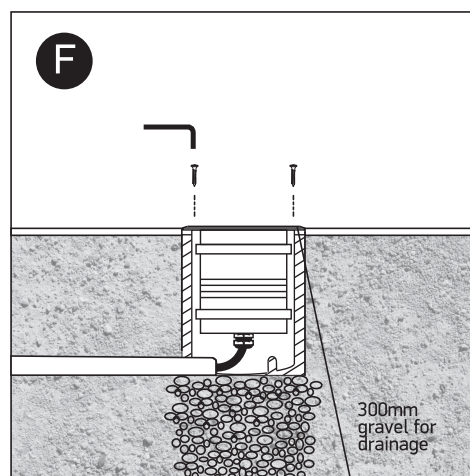
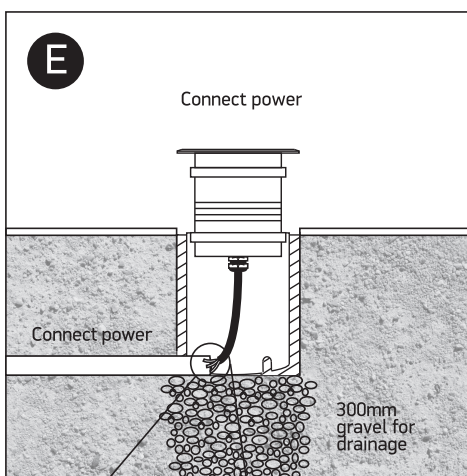
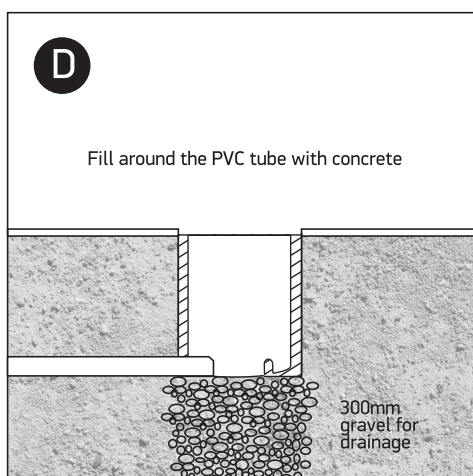
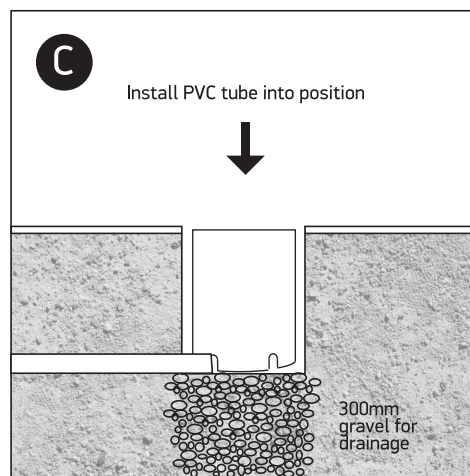
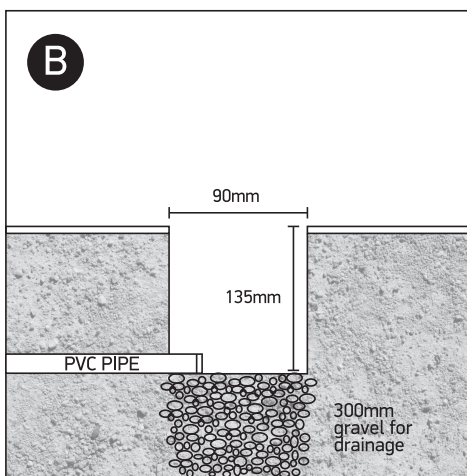
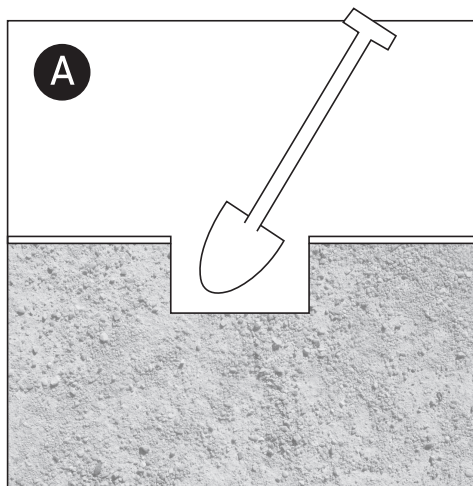
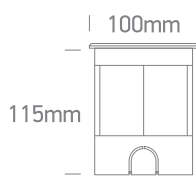

Tilttable beam $\pm 20^\circ$.

Warnings:

1. Make sure that the product is installed properly before connecting to electricity.
2. Do not cover the fitting.
3. Maintenance and installation should only be carried out by a professional electrician.

INSTALLATION MANUAL

69074A



230V | COB LED | 3x1,5W | IP67
 Stainless steel 316L + Die cast aluminium body
 Tilttable beam.
 Complete with driver.

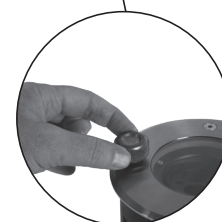
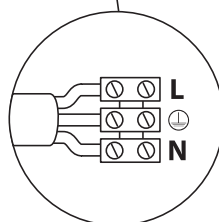
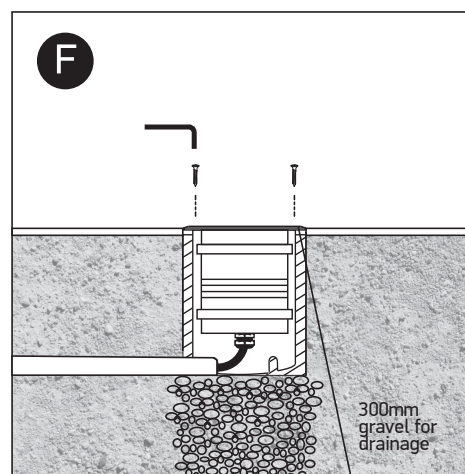
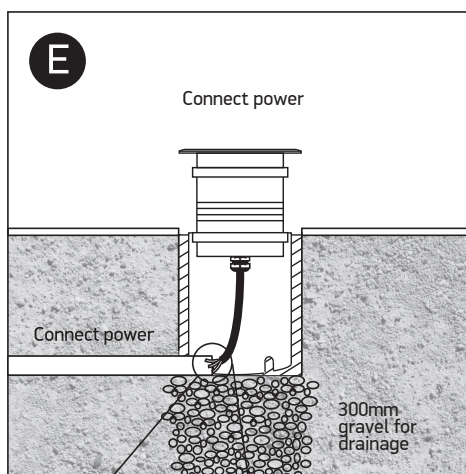
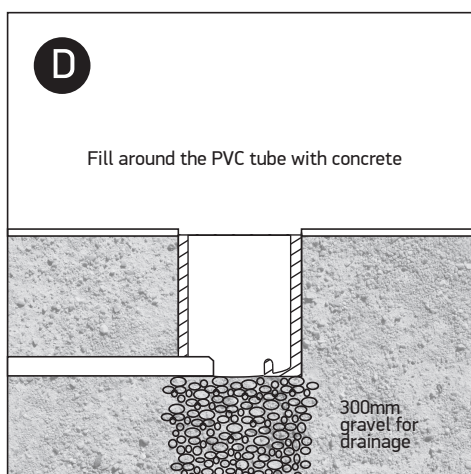
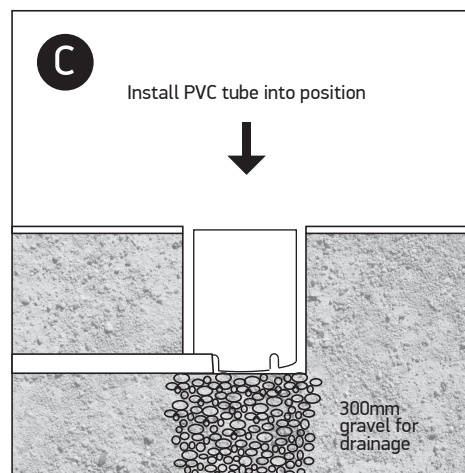
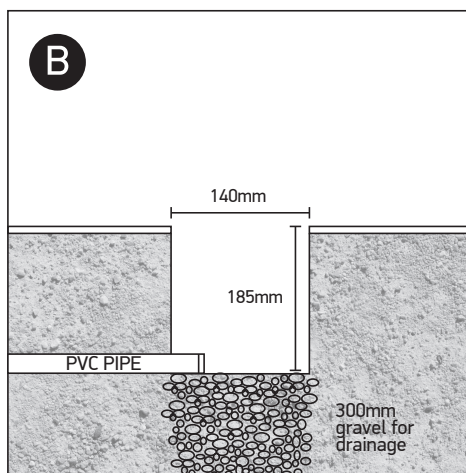
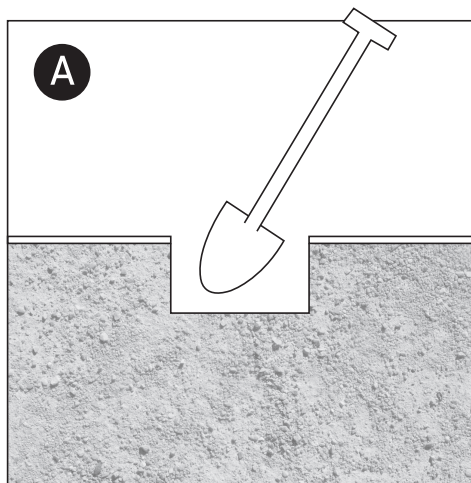
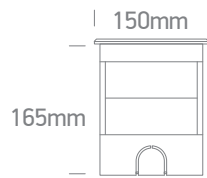

Tilttable beam $\pm 20^\circ$.

Warnings:

1. Make sure that the product is installed properly before connecting to electricity.
2. Do not cover the fitting.
3. Maintenance and installation should only be carried out by a professional electrician.

INSTALLATION MANUAL

69074B



230V | COB LED | 9x1,5W | IP67
 Stainless steel 316L + Die cast aluminium body
 Tilttable beam.
 Complete with driver.

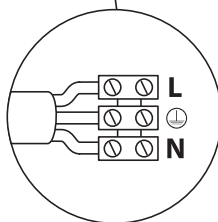
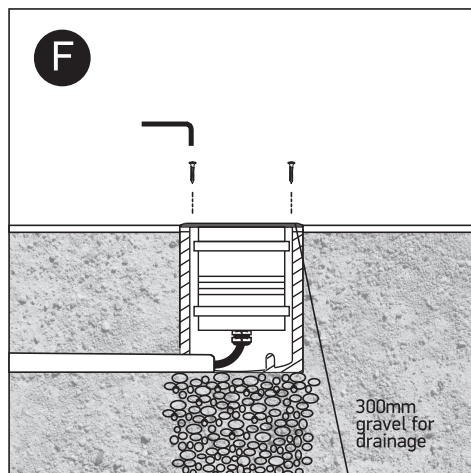
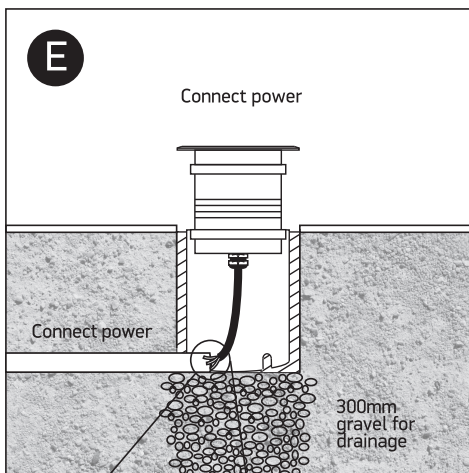
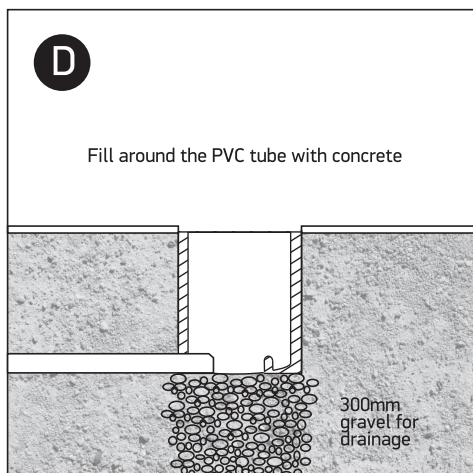
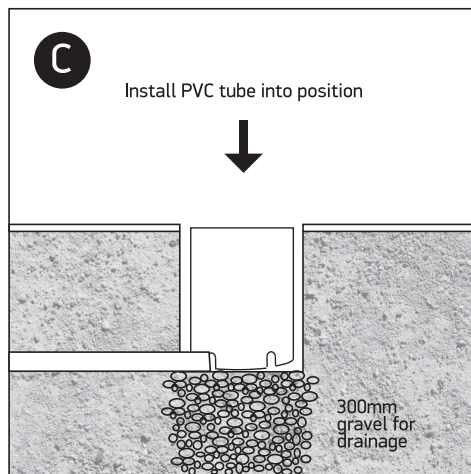
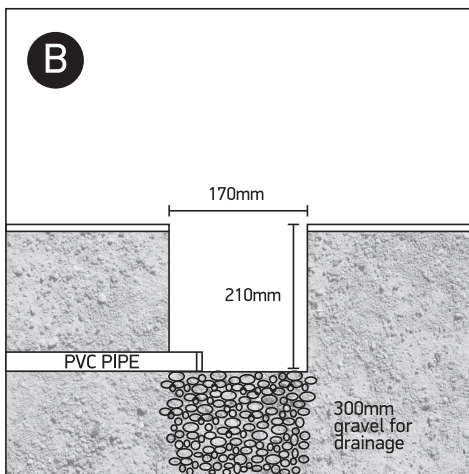
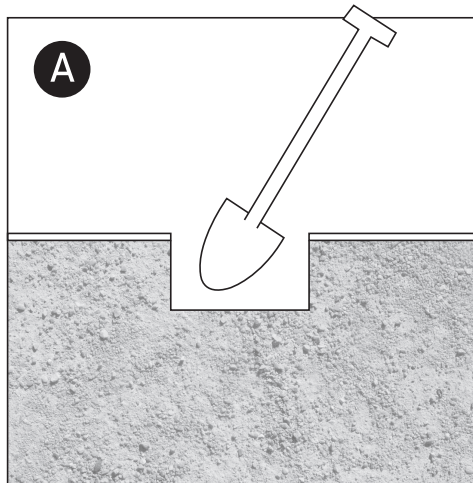
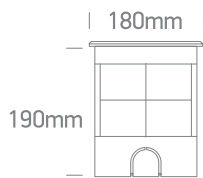

Warnings:

1. Make sure that the product is installed properly before connecting to electricity.
2. Do not cover the fitting.
3. Maintenance and installation should only be carried out by a professional electrician.

INSTALLATION MANUAL

69074C



230V | COB LED | 12x1,5W | IP67
 Stainless steel 316L + Die cast aluminium body
 Tilttable beam.
 Complete with driver.

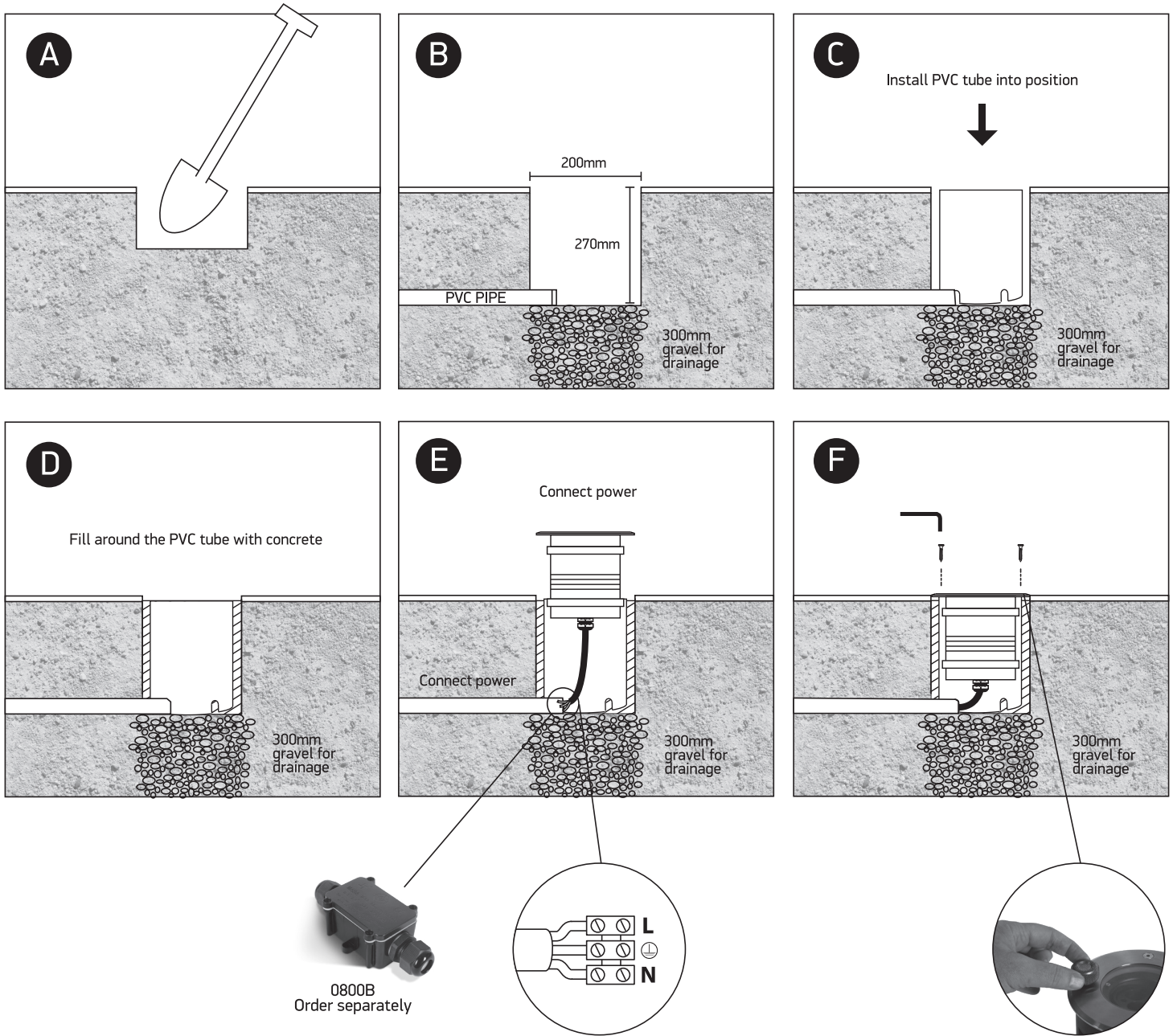
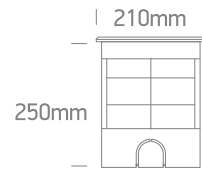

Warnings:

1. Make sure that the product is installed properly before connecting to electricity.
2. Do not cover the fitting.
3. Maintenance and installation should only be carried out by a professional electrician.